

Operating instructions

Hydraulic rescue equipment

CUTTERS

COMBI TOOLS



S 50, S 220-54, S 270-71, C 100-31, S 33-14, S 140-26 LIGHT,
SPS 270 MK2, SPS 360 L, SPS 370, SPS 400, SPS 270 H, SPS 270 LIGHT,
RSX 105-29, RSX 160, RSX 165-65, RSX 180-80, RSX 175-105, RSX 185 ALL NINE,
RSX 200-107, RSU 180 PLUS, RSU 200-107 PLUS, RSU 210 PLUS

8142610



tested according to
EN 13204 and NFPA 1936

WEBERRESCUE
SYSTEMS

www.weber-rescue.com

Table of Contents

1	General information	4
1.1	About the operating manual	4
1.2	Explanation of symbols	5
1.3	Limitations of liability	6
1.4	Copyright	6
1.5	Warranty conditions	7
1.6	Customer service	7
2	Safety	8
2.1	Intended use	8
2.2	Responsibility of the customer	10
2.3	Operating personnel	11
2.4	Personal protective equipment	12
2.5	Specific hazards	13
2.6	Safety devices	15
2.7	How to respond in the event of danger or accidents	16
2.8	Signage	17
3	Technical data	18
3.1	Cutters	18
3.2	Combi tools	21
3.3	Operating conditions	22
3.4	Type plate	22
4	Structure and function	23
4.1	Overview	23
4.2	Brief description	23
4.3	Hydraulic supply	24
4.4	Equipment connections	26
4.5	Use of the control handle	28
4.6	Changing the spreader tips (combi tools)	29
4.7	Replacement of blade inserts (PLUS-cutters)	29
4.8	Upgrade Set for RS 170, RSX 165-65, S 270-71 und RSX 200-107	31

5	Possible applications	32
5.1	Safety information	32
5.2	Cutting	32
5.3	Spreading (combi tools)	34
5.4	Pulling (combi tools)	34
5.5	Crushing (combi tools)	36
5.6	Lifting (combi tools)	36
5.7	Continuous cuts (C 100-31)	37
5.8	Pressing (combi tools with RZM 740)	37
6	Transport, packaging and storage	38
6.1	Safety information	38
6.2	Transport inspection	38
6.3	Symbols on the packaging	39
6.4	Disposal of packaging	39
6.5	Storage	39
7	Installation and commissioning	40
7.1	Safety information	40
7.2	Checking	41
7.3	Installation	41
7.4	Shutting down (end of work)	42
8	Service	43
8.1	Safety information	43
8.2	Care and maintenance	43
8.3	Maintenance schedule	44
9	Malfunctions	45
10	Decommissioning / recycling	46
11	EC Declaration of Conformity	47

1 General information

1.1 About the operating manual

This operating manual provides important information on using the hydraulic rescue cutters and combi tools. Proper compliance with all specified safety instructions and guidelines is a prerequisite for safe work.

Furthermore, adhere to the local accident prevention guidelines and general safety regulations for the region in which the devices are used.

These operating instructions must be carefully read prior to starting any work! They are an inherent part of the product and must be kept in a place that is known and accessible to personnel at all times.

This documentation contains information for operating your equipment. However, you may also find information which may not directly apply to your specific equipment.

All information, technical data, graphics and diagrams contained in these operating instructions are based on the latest data available at the time of the document's creation.

We recommend that, in addition to carefully reading through the operating manual, you be trained on handling the rescue equipment (possible applications, application tactics, etc.) by our qualified trainers.

1.2 Explanation of symbols

Warnings

Warnings are marked by symbols in this operating manual.

The individual instructions are introduced by signal words that express the severity of the hazard.

It is essential to comply with the instructions in order to prevent accidents, injuries and damage to property.



DANGER!

... indicates an imminently dangerous situation that can result in death or serious injury if not avoided.



WARNING!

... indicates a potentially dangerous situation that can result in death or serious injury if not avoided.



CAUTION!

... indicates a potentially dangerous situation that can result in minor or light injuries if not avoided.



ATTENTION!

... indicates a potentially dangerous situation that can result in material damage if not avoided.

Tips and recommendations



NOTE!

... highlights useful tips and recommendations, as well as information for efficient, trouble-free operation.

1.3 Limitations of liability

All information and instructions in this operating manual have been compiled in keeping with applicable standards and guidelines, the current state of technology, and our many years of knowledge and experience.

The manufacturer assumes no liability for damage due to:

- Failure to comply with the operating manual
- Unintended use
- Assignment of untrained personnel
- Unauthorised modifications
- Technical changes
- Use of non-approved replacement parts
- Use of non-original replacement parts

The actual scope of delivery can vary from the explanations and graphic representations provided in this manual in the case of special versions or due to technical changes.

1.4 Copyright

All text, diagrams, drawings and images in this operating manual may be used without restriction and without any prior approval.



NOTE!

Further information, images and drawings can be found on our website www.weber-rescue.com

1.5 Warrenty conditions

The guarantee conditions can be found as a separate document in the sales documentation.

1.6 Customer service

Our customer service is available to you for technical information.

Germany

Name: Mr. Bernd Dürr
Telephone: + 49 (0) 7135 / 71-10530
Fax: + 49 (0) 7135 / 71-10396
E-Mail: bernd.duerr@weber-rescue.com

Austria

Name: Mr. Matthias Schmid
Telephone: + 43 (0) 7255 / 6237-12473
Fax: + 43 (0) 7255 / 6227-12461
E-Mail: matthias.schmid@weber-rescue.com



NOTE!

When contacting our customer service department please state your equipment's designation, type and production year. These details can be found on the equipment type plate.

2 Safety

This section of the operating manual provides a comprehensive overview of all the important safety aspects for optimal protection of operating personnel, as well as for safe and trouble-free operation.

Significant hazards can occur if the handling and safety instructions in this manual are not complied with.

2.1 Intended use

The hydraulic cutters are designed and tested exclusively for the appropriate designated purposes described here. All other activities are fundamentally prohibited.

Cutters S 50, S 220-54, S 270-71, C 100-31, S 33-14, S 140-26 LIGHT, RSX 105-29, RSX 160, RSX 165-65, RSX 180-80, RSX 175-105, RSX 185 ALL NINE, RSX 200-107, RSU 180 PLUS, RSU 200-107 PLUS, RSU 210 PLUS

- All of the cutters are designed as one-man devices and may therefore be operated by one person only.
- The devices serve exclusively for the cutting of doors and roof pillars, posts and sills, the rims and spokes of steering wheels.
- The rear cutter section should be used whenever possible for separating solid material as this is equipped with special round material cutters.
- In industrial applications the equipment can also be used for cutting pipes, construction steel, profiles, sheets and cables.

Combi tools SPS 270 MK2, SPS 360 L, SPS 370, SPS 400, SPS 270 H, SPS 270 LIGHT

- All combi tools are designed as one-man devices and therefore may be operated by one person only.
- The devices serve exclusively for the cutting of doors and roof pillars, posts and sills, the rims and spokes of steering wheels.
- The rear cutter section should be used whenever possible for separating solid material as this is equipped with special round material cutters.
- In industrial applications the equipment can also be used for cutting pipes, construction steel, profiles, sheets and cables.
- In addition, the combi tools can be used for opening doors, lifting vehicles, pushing away vehicle parts and squeezing tubes.
- The chain set is to be used exclusively for pulling.

**WARNING!****Improper use can be dangerous!**

Any improper or unintended use of the devices can be hazardous!

Therefore, make absolutely sure that:

- » The devices are used only for the applications stated above.
- » All other information on proper use of the devices in chapter 5 (Possible applications) is observed.

2.2 Responsibility of the customer

In addition to the health and safety instructions in this operating manual, one must adhere to the safety, accident prevention, and environmental protection guidelines for the region in which the equipment is used. Particularly applicable in this regard:

- The customer must be familiar with the applicable health and safety provisions and in a hazard analysis identify other hazards that may exist at the equipment's installation site due to the special working conditions.
- The customer must clearly regulate and specify responsibilities for installation, operation, maintenance and cleaning.
- The customer must ensure that all personnel who handle the equipment have fully read and understood the operating manual.
- In addition, at regular intervals, the operator must train personnel and inform them of the hazards of working with the equipment.

Moreover, the customer is responsible for ensuring that the equipment is always in technically faultless condition. Consequently, the following applies:

- After each use, and at least once a year, a visual inspection of the equipment must be carried out by a trained individual (according to DGUV 305-002 or country-specific guidelines).
- Every three years, or if you have doubts about the safety or reliability of the equipment, functional testing and stress testing must be carried out (according to DGUV 305-002 or country-specific guidelines).

2.3 Operating personnel

The following qualifications are cited in the operating manual for the various activity areas:

- **Trained individual**
is informed through training offered by the customer about the tasks assigned to him and the possible dangers of improper conduct.
- **Specialist**
is someone who, due to specialised training, skills and experience, as well as knowledge of the applicable stipulations by the manufacturer, is capable of executing the tasks assigned to him or her and of independently recognising possible hazards.



WARNING!

Inadequate training can result in injuries!

Improper handling of the equipment can lead to serious injury or material damage.

Therefore, make absolutely sure to:

- » allow particular tasks to be carried out only by the persons stated in the relevant chapter of this manual.
- » When in doubt, call in specialists immediately.



NOTE!

The equipment may not be used by personnel who have consumed alcohol, medication or drugs!

2.4 Personal protective equipment

Wearing personal protective equipment (PPE) is essential to minimize the risks to operating personnel when working with the hydraulic rescue devices.

It is essential to wear the following protective clothing for all work:



Protective work clothing

Tight-fitting work clothing with tight sleeves and no protruding parts must be worn when working. It mostly serves to protect against entanglement by moving equipment parts.



Safety shoes

Steel-toed safety shoes must always be worn as protection against heavy falling parts and from slipping on slick surfaces.



Work gloves

Work gloves must be worn when working with the equipment to provide protection from sharp edges and shards of glass.



Helmet with face shield

A helmet with face shield must be worn for protection against flying or falling parts and shards of glass.



Protective goggles

Protective goggles must also be worn in addition to the face shield in order to protect the eyes from flying objects.

The following must also be worn for certain work:



Ear protectors

In addition to the basic protective equipment, ear protectors must also be worn to protect your hearing.

2.5 Specific hazards

The hazards arising from the risk analysis are listed in the following section.

Follow the safety instructions listed here and the warnings in the other sections of this manual to minimise potential health hazards and avoid dangerous situations.

Electricity



DANGER!

Danger of fatal electric shock!

There is an imminent life-threatening danger if live parts are touched. Damage to insulation or to specific components can pose a fatal hazard.

Therefore:

- » If the insulation is damaged, immediately disconnect the power supply and arrange for repairs.
- » Allow only qualified electricians to work on the electrical equipment.
- » For all work on the electrical equipment, it must be disconnected from the power source, and it must be checked that the device is de-energised.
- » Prior to maintenance, cleaning and repair work, the power supply must be switched off and secured to prevent it from being switched back on again.
- » Do not bypass or disable fuses.
When changing the fuses, ensure that they have the correct amperage.
- » Keep moisture away from live parts.
This can lead to a short-circuit.

Noise



WARNING!
Noise can damage hearing!

The noise occurring in the work area can cause severe hearing damage.

Therefore:

- » You should also wear ear protectors when carrying out certain noise-producing tasks.
- » Do not stay in the hazardous area longer than necessary.

Hydraulic power



WARNING!
Hydraulic power hazard!

Serious injury can result due to the released hydraulic forces and escaping hydraulic oil.

Therefore:

- » Constantly monitor the device during the work procedure and set down if necessary.
- » Inspect the hose lines and devices for damage after every use.
- » Avoid skin contact with the hydraulic oil (wear protective gloves).
- » Immediately remove the hydraulic oil from wounds and consult a doctor.

2.6 Safety devices

Safety valve for SKS couplings

If the return line is not correctly coupled such that the oil cannot return then a safety valve integrated into the control handle actuates in order to protect the equipment and the operator. This causes hydraulic oil to seep harmlessly from the end of the handle.

Move the switching valve on the hydraulic power unit immediately to the „0“ position and connect the coupling parts together correctly.

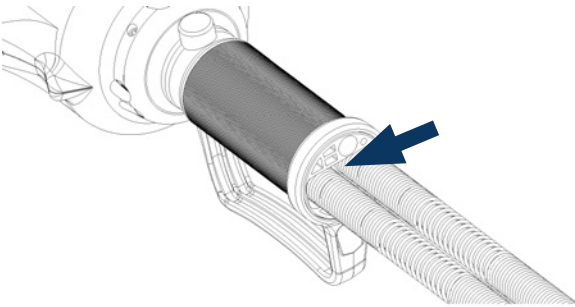

2.7 How to respond in the event of danger or accidents

Preventative measures

- Always be prepared for accidents
- Keep first aid equipment (first-aid box, blankets etc.) at hand
- Familiarise personnel with accident alarms, first-aid gear and emergency equipment
- Keep entryways clear for emergency vehicles

In the event of an accident

- Shut down equipment immediately
- Initiate first aid measures
- Get people out of the danger zone
- Inform the responsible parties at the site of the incident
- Notify a doctor and/or the fire brigade
- Clear entryways for emergency vehicles

2.8 Signage

The equipment bears the following symbols and instructional signs. They refer to the immediate vicinity in which they are affixed.



Comply with the operating manual

Do not use the marked equipment until you have read the operating manual.



Hand injury warning

When working with the equipment, take care to avoid hand injuries through trapping or sharp edges.



WARNING!

Danger of injury due to illegible symbols!

Over time, stickers and symbols on the equipment can become soiled or otherwise illegible.

Therefore, make absolutely sure to:

- » Keep all safety, warning and operating information on the device easily legible.
- » Replace damaged signs and stickers immediately.

3 Technical data

3.1 Cutters



RSX 105-29



S 140-26 LIGHT



RSX 160



RSX 165-65



RSX 175-105



RSX 185 ALL NINE

	RSX 105-29	S 140-26 LIGHT	RSX 160	RSX 165-65	RSX 175-105	RSX 185 ALL NINE
Length	575 mm	642 mm	718 mm	711 mm	811 mm	866 mm
Width	184 mm	172 mm	236 mm	225 mm	298 mm	298 mm
Hight	205 mm	198 mm	158 mm	202 mm	221 mm	225 mm
Weight	9,3 kg	7,9 kg	14,5 kg	16,3 kg	22,0 kg	22,4 kg
Opening width	105 mm	143 mm	160 mm	150 mm	170 mm	265 mm
Nominal pressure	700 bar	700 bar	700 bar	700 bar	700 bar	700 bar
EN class	AC105E-9,3 -	AC115D-7,9 1F-2D-3D-4D-5G	BC160H-14,5 1I-2K-3H-4J-5H	BC165F-16,3 1J-2F-3G-4J-5G	BC170H-22,0 -	CC240K-22,4 1K-2K-3K-4K-5K
NFPA class	A5-B4-C5-D6-E6	A5-B3-C3-D6-E7	A7-B8-C6-D7-E8	A8-B6-C6-D7-E9	A8-B9-C8-D9-E9	A9-B9-C9-D9-E9
ID No.	5936780	1075652	1093226	5932068	5932939	1093248



RSU 180 PLUS



RSX 180-80



RSX 200-107



RSU 200-107 PLUS



RSU 210 PLUS

	RSX 180-80	RSU 180 PLUS	RSX 200-107	RSU 200-107 PLUS	RSU 210 PLUS
Length	740 mm	736 mm	833 mm	833 mm	833 mm
Width	232 mm	236 mm	265 mm	260 mm	260 mm
Height	206 mm	159 mm	217 mm	162 mm	163 mm
Weight	17,6 kg	16,7 kg	19,7 kg	19,8 kg	19,6 kg
Opening width	180 mm	185 mm	200 mm	200 mm	210 mm
Nominal pressure	700 bar	700 bar	700 bar	700 bar	700 bar
EN class	BC180I-17,6 1J-2K-3I-4J-5J	BC185J-16,7 1J-2K-3K-4K-5K	CC200J-19,7 1J-2K-3K-4K-5J	CC200I-19,8 1J-2K-3I-4K-5J	CC200K-19,6 1K-2K-3K-4K-5K
NFPA class	A7-B9-C7-D9-E9	A8-B9-C7-D9-E9	A8-B9-C8-D9-E9	A8-B9-C8-D9-E9	A8-B9-C8-D9-E9
ID No.	1059226	1093279	5935849	1069498	1093298



C 100-31



S 50



S 33-14



S 220-54



S 270-71

	C 100-31	S 50	S 33-14	S 220-54	S 270-71
Length	585 mm	362 mm	388 mm	728 mm	762 mm
Width	205 mm	138 mm	71 mm	236 mm	225 mm
Height	247 mm	71 mm	129 mm	196 mm	202 mm
Weight	19,5 kg	4,2 kg	3,9 kg	14,4 kg	16,6 kg
Opening width	120 mm	50 mm	30 mm	220 mm	280 mm
Nominal pressure	700 bar	700 bar	700 bar	700 bar	700 bar
EN class	AC120C-19,5 -	AC50B-4,2 1C-2D-3B	-	BC170H-14,4 1I-2H-3H-4K-5I	CC218I-16,6 1I-2K-3I-4K-5J
NFPA class	A4-B3-C5-D6-E6	A4-B3-C2-D4-E3	A3-B2-C1-D2-E2	A7-B7-C6-D8-E8	A7-B8-C7-D8-E9
ID No.	5935199	1093906	2836661	1063372	5932084

3.2 Combi tools



SPS 270 H



SPS 270



SPS 270 LIGHT



SPS 360 L



SPS 370



SPS 400

	SPS 270 H	SPS 270 LIGHT	SPS 270 MK2	SPS 360 L	SPS 370	SPS 400
Length	682 mm	708 mm	649 mm	765 mm	771 mm	807 mm
Width	192 mm	190 mm	192 mm	236 mm	236 mm	236 mm
Height	161 mm	196 mm	199 mm	203 mm	203 mm	206 mm
Weight	9,8 kg	8,9 kg	9,7 kg	14,9 kg	16,0 kg	18,1 kg
Opening width	270 mm	270 mm	270 mm	360 mm	370 mm	420 mm
Pulling path	380 mm	380 mm	380 mm	396 mm	346 mm	402 mm
Spreading force in working range*	32 – 534 kN	34 - 591 kN	34 – 591 kN	39 – 783 kN	36 – 783 kN	36 – 1.071 kN
Max. pulling force*	30 – 41 kN	30 – 41 kN	30 – 41 kN	39 – 49 kN	41 – 59 kN	98 kN
Nominal pressure	630 bar	700 bar	700 bar	700 bar	700 bar	700 bar
EN class	BK26/270G-9,8 1H-2G-3G-4H-5G	BK31/270G-8,9 1H-2G-3G-4H-5G	BK31/270G-9,7 1H-2G-3G-4H-5G	CK37/360H-14,9 1I-2J-3H-4K-5J	CK37/370H-16,0 1I-2J-3H-4J-5I	CK36/420I-18,1 1I-2K-3I-4K-5K
NFPA class	A6-B7-C6-D7-E7	A6-B7-C6-D7-E7	A6-B7-C6-D7-E7	A7-B8-C7-D8-E8	A7-B8-C7-D8-E8	A7-B9-C7-D9-E9
ID No.	1084065	1086181	1086140	1062580	1063314	5931134

* per EN 13204

The permissible operating temperature range for the cutters lies between -20°C and $+55^{\circ}\text{C}$. Reliable functioning of the equipment cannot be guaranteed outside this range.

Underwater operation

The cutters (exception: SPS 270 H) can also be used under water. Do not exceed the maximum submersion depth of 40 metres with this. At this depth the water pressure still has no influence on the hydraulic pressure in the equipment and the hoses.



NOTE !

After underwater use in saltwater, the equipment must be completely disassembled and cleaned. With fresh water complete cleaning is sufficient.

3.4 Type plate

The type plate can be found on the device body of all cutting devices. Here you can find the serial number, manufacturing date, nominal pressure, equipment designation and the EN standard.

4 Structure and function

4.1 Overview

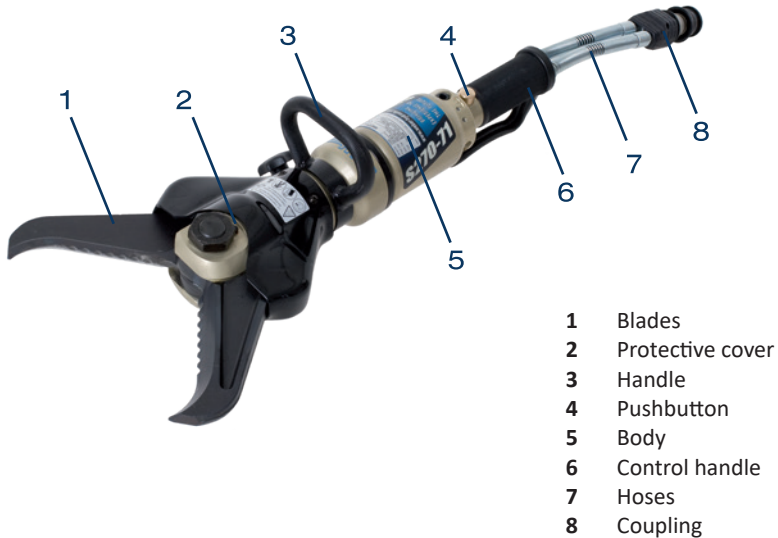

4.2 Brief description

Hydraulic cutters are specially designed rescue equipment for cutting bodywork parts. They are used for rescuing trapped or enclosed accident victims.

Driven by a hydraulic power unit it is possible to cut door and roof pillars, posts and sills etc. with the cutters.

The speed of movement of the shearing blades is controlled by the greater or lesser degree of force applied to the pushbutton on the handle. The maximum cutting force is only applied when the pushbutton is fully depressed.

4.3 Hydraulic supply

Power units and pumps

Only WEBER-HYDRAULIK power units and hand pumps may be used to drive the cutters. Equipment from other manufacturers can only be used under certain conditions. Therefore always consult with us before operating a device with a power unit from another manufacturer!



ATTENTION !

Before using pumps and power units from other manufacturers always contact WEBER-HYDRAULIK or an authorised dealer.

Incorrect application can lead to hazardous situations for which we cannot accept any liability!

Hoses

The connection of the device with the power unit is carried out via high pressure hoses. Hoses are available in lengths of 5 m, 10 m, 15 m and 20 m. As the length of the hoses increases so too does the associated pressure loss. With a line length of 50 metres this pressure loss remains acceptable and has no significant effect.



CAUTION !

Do not use damaged hoses !

With damaged hoses there is a danger of escaping hydraulic medium under pressure, or of the hoses whipping around.

Therefore:

- » The hoses should be subjected to a visual inspection (leak-tightness, surface damage such as kinks) after every use and at least once per year.

- » Every three years, or in the event of doubts about the safety or reliability, carry out an additional functional and load test (as per DGUV 305-002 or specific national directive).
- » Replace hoses every 10 years! The date (code letters or quarter/year) is specified on the hose bonding.
- » Ensure that the hoses are not exposed to tension or torsion (turning).
- » Do not kink the hoses or draw them over edges (smallest bend radius 40 mm).
- » Do not subject the hoses to high temperatures.
- » Protect hoses from contact with materials that can cause damage to the outer covering e.g. acids, alkalis, or solvents.

Hydraulic oil

All cutters are designed and tested for WEBER hydraulic oil ID No. 804932. This oil possesses a particularly high purity level and also works flawlessly at temperatures below zero, down to -20° C.

With limitations in the low temperature range (low output), however, a standard oil (mineral based) of viscosity class HLP 10 or HVLP 10 can be used in keeping with DIN 51502.



NOTE !

We recommend the following hydraulic oils for trouble-free operation of WEBER rescue devices:

- » AERO Fluid 41 (Shell)
- » Univis HVI-13 (Esso)
- » Aero-hydraulic 520 (Total)
- » Hydraulik DB (Castrol)
- » Renolin/MR310 (Fuchs)
- » HVI Extra 380 (Maier & Korduletsch)
- » Hydrex Arctic 15 (Petro Canada)
- » Naturelle HFE 15

4.4 Equipment connections

SINGLE coupling

Connecting:

Remove the protective cap from the coupling male and the coupling female (Fig. 1).

Conflate SINGLE coupling male and female in the bayonet catch (Fig. 2). Hold coupling female on the black slew ring and turn clockwise until the coupling snaps in (Fig. 3). Put protective caps together (Fig. 4). You don't have to switch the power unit to position 0 to connect or disconnect the coupling!

Disconnecting:

Remove the protective caps. Hold coupling female on the black slew ring and turn anticlockwise direction. Turn the black slew ring until you can release the coupling easily. Put protective caps to coupling male and the coupling female.



Fig. 1



Fig. 2



Fig. 3



Fig. 4



NOTE !

When using the SINGLE coupling, pressure relief connectors are no longer required.

Plug-in coupling (SKS)

Connecting:

Remove the protective cap from the coupling male. Take hold of the coupling female by the knurled sleeve cover and pull out the protective plug. With one hand take hold of sleeve cover of the coupling female, with the other grasp the coupling male (black) by the hex nut, and press the sleeve cover slightly against the coupling male until the ball bearings engage. Twisting the male coupling slightly when pressing together eases the coupling process.

Disconnecting:

Grasp the coupling male (black) by the hex nut with one hand and with the other take hold of the sleeve cover and draw it back. The disconnecting will cause a few drops of hydraulic oil to escape. Plug in the protective caps immediately.

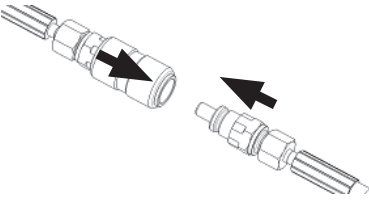

CAUTION !

When coupling SKS connections the power unit operating lever must be in the „0“ position.



NOTE !

A pressure relief connector is fitted to the hydraulic power units and the hand pump, with which a few drops of oil can be discharged from the hoses. This permits re-coupling following pressure increases in de-coupled equipment.

In this case simply insert the pressure relief connector into the coupling sleeve and turn the knurled screw to the right until oil leaks out.

**NOTE !**

The following section only pertains to the SINGLE coupling. When connecting SKS couplings first ensure that the control lever is in the „0“ position!

4.5 Use of the control handle

The cutter can be operated by the pushbutton on the control handle. The speed of movement of the shearing blades is controlled precisely by the greater or lesser degree of force applied to the pushbutton.

The maximum cutting force is only applied when the pushbutton is fully depressed.

Closing the cutters

The primary motion direction of the device (closing) is triggered by pressing the lower tapered (convex) end of the button.

The direction of movement is marked on the equipment with the symbol:



Opening the cutters

The cutters are opened with the upper curved (concave) end of the button, which is marked with the following symbol:



Dead-man's switching

If the pushbutton is released then it returns to the neutral position automatically. With this, the device stops still in any position (including under load).

4.6 Changing the spreader tips (combi tools)

The SPS 370/400 spreader tips are secured with pivot pins in the spreader arms. In order to change, press out the pins secured by a spring-loaded ball. After changing the tips, push the pivot pins back in again. When doing this ensure that the pins are correctly fitted (completely pressed in).

Fitting the bracket for the chain set is identical, however an appropriate pulling adapter must also be fitted before. The chain lock must be fitted with the lock facing upwards.

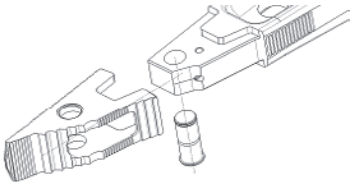

NOTE !

Fitting the chain lock to the SPS 270 H, SPS 270 MK2 and SPS 360-L is exactly the same. However, in this case it is not necessary to remove spreader tips beforehand.

4.7 Replacement of blade inserts (PLUS-cutters)

During blade replacement, the cutter is fixed in place. Any slipping should be avoided. Replacing the blade requires a soft-face hammer, the roll pins supplied, a punch and the blade inserts themselves. It makes sense to replace both blade inserts so that the cutting behaviour is not impaired.



NOTE!

The blade inserts should not be reground, simply cleaning off any soiling is recommended.

Procedure:



Fig. 1

The cutter is positioned with the type plate pointing upward and is fixed in place. A clamping device, as shown in the illustrations, is not obligatory. When the blade insert is being changed, the battery must be removed from the cutter and not under load. This means that the shear is not completely open or closed.

The blade insert for the cutter blade with the smooth surface can now be replaced.

The roll pins are knocked out and downward from the punch (see figure 1).



Fig. 2

After the roll pins have been knocked out of their position, the blade insert can be pulled out. The use of a forked screwdriver is recommended. If the blade insert cannot be loosened immediately, it can be gently levered out using a punch in the holes.



Fig. 3

Next, the cutter is rotated and the blade insert is placed in the cutter blade with no insert.

When inserting, make sure that the blade insert does not twist. If the blade inserts cannot be inserted by hand, use the soft-head hammer (see figure 3).



The roll pins are located using a punch and light blows of a hammer from above into the position holes provided for this purpose. Roll pins should be pushed into position until they are flush with the top surface of the blade (see figure 4).

Fig. 4

4.8 Upgrade Set for RS 170, RSX 165-65, S 270-71 and RSX 200-107



Upgrade to RSX 180-80 PLUS		Weight	ID No.
RS 170-105	Upgrade set	8,3 kg	1062138
RSX 165-65	Upgrade set	8,3 kg	1062134
S 270-71			
Upgrade to RSX 200-107 PLUS			
RSX 200-107	Blade without insert	3,6 kg	1050397
	Blade insert	0,3 kg	1056095
	Complete blade (with insert)	3,9 kg	1052563
	Sleeve	0,4 kg	1056418
Upgrade to RSU 200-107 PLUS			
RSX 200-107 / RSX 200-107 PLUS	Blade without insert	3,3 kg	1072763
	Blade insert	0,3 kg	1075983
	Complete blade (with insert)	3,6 kg	1078502

5 Possible applications

5.1 Safety information



WARNING !

Never reach between the cutter arms!



WARNING !

During all work with the cutters, parts which are tensioned can break off or be blown off and thus endanger personnel.

Uninvolved parties must therefore remain a safe distance away or stay in the danger zone only as long as necessary.

5.2 Cutting

The devices' cutting capabilities can only be used optimally if they are placed as near as possible to the blades' pivot point (Figure 1).

This means it may be necessary to readjust the device.

The device only achieves full cutting performance when the rocker lever is pressed all the way through. In addition, it can take several seconds for the unit to reach full operating pressure.

Fig. 1

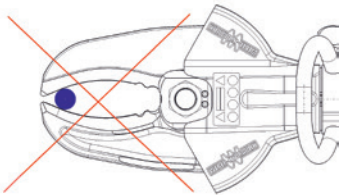
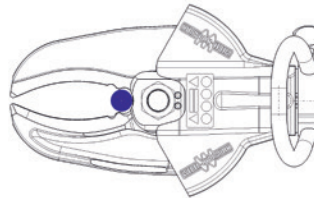

Fig. 2



To prevent the blades from being damaged, they must always be placed at right angles to the material to be cut.

Also, the tips of the blades must not be more than 5 mm (3 mm for S 50) apart during the cutting process. If this value is exceeded, the cutting process must be stopped and then started again.

**CAUTION !**

Do not sever any parts with loose ends, because this can result in personal injury due to parts flying off.

**ATTENTION !**

When cutting high-strength vehicle body parts, such as shock absorbers, hinges or steering columns, the shear blades (arms) may cause severe damage.

5.3 Spreading (combi tools)

The spreading function's uses include opening doors, lifting vehicles and other movable loads, pushing vehicle parts away, and squashing tubes and beams. For this, the vehicle must be stably stabilized and supported.

To prevent any sliding during spreading, the arms and tips are fluted inside and out. Whenever possible, the tips should be used only to enlarge a gap, because repositioning the spreader prevents slipping.

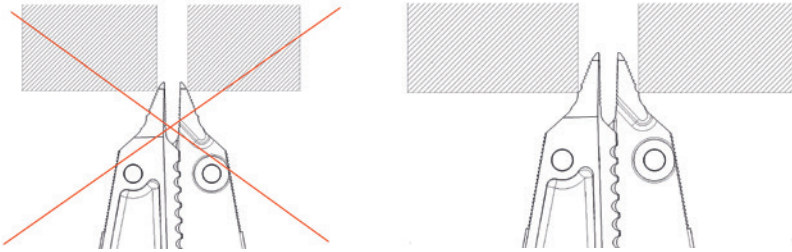

5.4 Pulling (combi tools)

After the chain set (as explained in chapter 4.6) has been mounted on the spreader tips, the combi device can also be used for pulling.

For this, the chains must be tightly tensioned and must be tensed only in the pulling direction. To tension the chain, only one lock can be pressed in, so that the chain can be pulled through the holder.

If the range of movement is not sufficient, tension chains or other means must be used so that the spreader can be reopened and the chain retensioned.

**ATTENTION !**

It is necessary to ensure that the lock has latched into the bracket securely.

**ATTENTION !**

Store the pulling chains with the chain locks fitted approx. 10 - 20 cm from the end. Check the chains before each use. Check that the weight does not load the point of the hook but rather lies in the middle of the hook.

- » Do not make any repairs on your own.
- » Do not stress the chains beyond the permitted load carrying capacity.
- » Do not load with a jerking movement.
- » Do not galvanize or paint the chains.
- » Do not shorten the chain by knotting it.
- » Do not subject the chains to heat stress.
- » Use the chains and accessories only between -40°C and $+200^{\circ}\text{C}$.
- » During all maintenance work, observe the applicable German accident prevention regulations (UVV) as well as the specifications of DIN EN 818-7 and DIN 685-5.
- » Chains must only be used for lashing. Lifting loads is not permitted.

Chains must not be used if:

- » Deformations, cracks, signs of corrosion are present.
- » The wire diameter of the chain link has decreased by 10% of the nominal thickness.
- » An individual chain link has been permanently stretched.
- » An individual link has been enlarged by more than 2%.
- » The internal chain pitch over a measuring distance of 11 chain links has increased by more than 2%.

5.5 Crushing (combi tools)

Pipes and other hollow profiles are crushed by closing the spreader arms. With combi devices, however, crushing is only to be performed in the tip area.

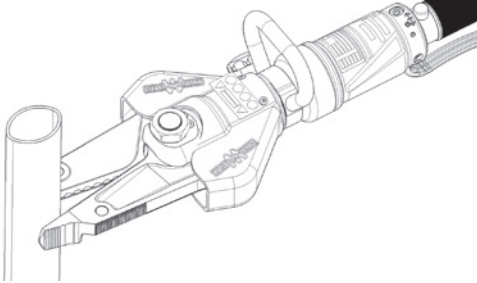

ATTENTION !

Material to be crushed can suddenly jump away.
Do not remain in the work area of the spreading and combi devices!

5.6 Lifting (combi tools)

The combi device can also be used for lifting vehicles or other movable loads. Care must be taken to secure the load against slipping away and to position the spreader tips far enough apart under the load to prevent slipping.

The load being lifted must be constantly monitored (tipping, rolling away or changing position). Also, the lifted load must immediately be propped up and supported in a suitable way.

5.7 Continuous Cuts (C 100-31)

Continuous Cuts are possible with the C 100-31 without the need for time-consuming V-cuts. Here the special cutting device is set at right angles to the object to be cut (drive in from above) and the cutter driven closed.

It is necessary to ensure that the cut-out piece falls from the ejection aperture. Then open the cutter again and re-insert it into the same cut. It is possible to continue to work vertically downwards in this way.

5.8 Pressing (combi tool with RZM 740)

In order to further increase the spreading path of the SPS 270 MK2, SPS 270 H and the SPS 360 L, it is optionally possible to fit a mechanical rescue cylinder to these two devices. These are inserted in the shear blades with spring-loaded bolts (see page 29, „4.6 Changing the spreader tips“). In order to ease insertion of the RZM 740, the blades should be slightly opened!

If the shear blades of the combi tool are now driven apart, the RZM 740 also opens up to a final length of 740 mm and in doing so applies a force of up to 35 kN.



ATTENTION!

Whilst pressing with the RZM 740, the combi tool moves towards the vehicle. Therefore avoid standing in the direct working area of the combi tool!



6 Transport, packaging and storage

6.1 Safety information



CAUTION!

Incorrect transport can cause damage!

Improper transport can cause significant material damage.

Therefore:

- » Proceed with caution when unloading the packages, and observe the symbols on the packaging.
- » Do not fully open and remove the package until it has reached its actual storage location.

6.2 Transport inspection

Upon receipt, the delivery should be checked immediately for completeness and damage during transport so that a quick remedy can be performed, if necessary.

If there is visible external damage, please proceed as follows:

- Do not accept the delivery, or only accept it with reservation.
- Note the extent of the transport damage on the transport documents or on the transport company's delivery note.
- File a complaint.



NOTE!

Report any defect as soon as it is detected.

Claims for damages can be directed to our customer service department (see Chapter 1.6).

6.3 Symbols on the packaging



Caution, fragile !

Handle the package carefully - do not drop, throw, strike or tie up.



This way up !

The package must be transported and stored strictly so that the arrows point upward. Do not roll or tilt.

6.4 Disposal of packaging



All packaging materials and disassembled parts (transportation protection) must be disposed of properly in accordance with applicable local regulations.

6.5 Storage

The equipment should be stored in a dry and dust-free environment where possible. Avoid direct UV radiation to the hoses.



CAUTION !

The equipment must be stowed securely in the mountings provided in order to avoid damage during transit, etc.

7 Installation and commissioning

7.1 Safety information



WARNING !

Danger of injury due to improper operation !

Improper operation can cause serious injury or material damage.

Therefore, make absolutely sure to:

- » All operating steps are executed in keeping with the information in this operating manual.
- » All covers and protective devices are installed and in proper working order prior to starting work.

Personal protective equipment

Wear the protective equipment detailed in chapter 2.4 for all work!



NOTE !

Special reference is made where it is necessary to wear additional protective equipment for certain work with or on the device.

7.2 Checking

Inspect the cutter devices for damage. If the cutting device is not in pristine condition, it must not be used! In this case, immediately contact your supplier.

- Check the blades (damage)
- Check the control handle including pushbutton (function)
- Check the couplings (damage, dirt)
- Check the hand grip (securely fastened)
- Check the protective cover (damage)
- Check the hoses (damage)

7.3 Installation

Move both control levers on the hydraulic power unit to the „0“ position (Fig. 1), pull off the dust protection cover on the coupling and connect the hydraulic hoses with the cutter as described in chapter 4.4. In order to avoid contamination then re-couple the protective caps. When using the SINGLE coupling, coupling can also be carried out without pressure („0“ position on power unit not necessary).

When operating a hydraulic power unit observe the operating instructions for the equipment!

Fig. 1

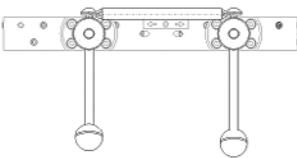

7.4 Shutting down (end of work)

After work is over, the blade tips must be placed one above the other to prevent injury. The blades of the cutting device must not be completely closed, as otherwise tension will build up in the device.



NOTE !

With combi tools, drive the spreader arms to within a few millimetres of each other in order to relieve the hydraulics.

Then the equipment can be disconnected providing that the power unit control lever is in the „0“ position. Care must be taken to ensure that no dirt ends up on the coupling and that the protective caps are immediately fitted.

8 Service

8.1 Safety information

**WARNING !****Risk of injury due to improperly performed maintenance work!**

Improper maintenance of the equipment can cause serious injury or material damage.

Therefore, make absolutely sure to:

- » Only let qualified personnel carry out maintenance work.
- » Make sure the installation site is organised and clean! Loose components and tools lying around are sources of danger.
- » Wear protective gloves for all work!

8.2 Care and maintenance

In the interest of permanent operational readiness, the following measures are essential:

- Each time the device is subjected to a load, but at least once a year, the equipment and the accessories must be visually inspected. Special attention must be paid to spreader tips, joints, blades, hoses, and coupling halves.
- Every three years, or if there are doubts about the safety or reliability of the equipment, functional testing and stress testing must also be carried out (according to DGUV 305-002 or country-specific guidelines).
- After every loading, the lubrication of the movable parts and pins must be inspected and sprayed with a suitable grease.
- The hydraulic oil in the cutting and combi tools must be completely replaced every three years.



ATTENTION !

Prior to all maintenance work, the equipment must be cleaned of any dirt so that it does not get into the hydraulic system.

The cleaning can be carried out using a conventional citrus cleaner.

8.3 Maintenance schedule

A precise maintenance plan with testing intervals, regulations and results can be found in the GUV – G 9102 Point 18 (hydraulically operated rescue equipment).



NOTE !

If there are any problems with the maintenance of the devices, our customer service is available (see Chapter 1.6).

9 Malfunctions

Fault	Possible cause	Remedial measures
Device does not reach full performance	Control buttons not fully depressed	Fully depress control buttons
Equipment delivers no power or moves in the opposite direction to that commanded	Pressure line (P) and return line (T) were transposed when hoses or couplings were replaced	Change round in accordance with the repair instructions
Cutter cannot be coupled	Pressure build-up due to heating (only SKS coupling) Coupling halves are damaged or heavily soiled	Drain a little oil out of the equipment with the pressure relief plug, see chapter 4.3 (only SKS coupling)
Oil escaping at the control handle (hole between the hoses)	Return hose is not correctly coupled (only SKS coupling)	Move power unit control lever to the "0" position and couple correctly (only SKS coupling)
Equipment non-functional despite actuating the control buttons	Pressure hose is not coupled	Move power unit control lever to the "0" position and couple correctly (only SKS coupling)
Combi tool exhibits movement in the opposite direction under load	Check non-return valve	Have the equipment checked by authorised customer services
Oil discharge on the hoses or their bondings	Hoses leaking, possibly due to damage	Replace hoses, see repair instructions
Degradation of the surfaces of the hoses	Contact with aggressive chemical fluids	Replace hoses, see repair instructions
Oil escaping at the coupling halves	Coupling leaking	Replace coupling, see repair instructions
Blades loose and gaping apart when cutting	Attachment of blades to the shearing head not in accordance with specifications	Repair by authorised customer service
Tip spread of cutter below target value	Shearing head settings incorrect	Repair by authorised customer service
Tip spread of combi tool below target value	Shearing head settings incorrect	Repair by authorised customer service
Pressure build up despite movement (open - closed) without any load	Hex nut / central bolt too firmly tightened	Repair by authorised customer service
Nick or gouge in blade	Blade damaged e.g. through cutting hardened materials	Can be reground up to approx. 2 mm (see repair instructions), otherwise replace
Chip or groove	Blade damaged e.g. through cutting high-strength materials	Have the blades replaced by authorised customer services

10 Decommissioning / Recycling

After the end of the normal service life, the equipment must be professionally disposed of. Individual parts can, however, certainly be used again.

The hydraulic oil must be completely drained and collected. Make sure that the hydraulic oil is disposed of separately!

For disposal of all device components and packaging materials, the disposal conditions of the specific location apply.



NOTE !

Please ask your supplier about disposing of the device.

11 EC Declaration of Conformity



WEBER-HYDRAULIK GMBH
Industriegebiet 3 + 4, A-4460 Losenstein, Austria

EC-DECLARATION OF CONFORMITY

according to Directive 2006/42/EC

Herewith we declare, that our "Hydraulic rescue Equipment"

SPREADERS	SP 35 AS, SP 40 EN, SP 40 C, SP 44 AS, SP 49, SP 50 BS, SP 54 AS, SP 53 BS, SP 60, SP 64 BS, SP 80, SP 84 BS
CUTTERS/COMBI-TOOLS	S 25-20, S 33-14, S 50 (-14), S 140-26 (LIGHT), S 220-54, S 270-71, C 100-31, RS 130-49, RS 170-105, RSU 180 PLUS, RSU 210 PLUS, RSX 105-29, RSX 160 (-50), RSX 165-65, RSX 180-80 (PLUS), RSX 185-(105), RSX 200-107 (PLUS), SPS 270 (LIGHT), SPS 270 MK2, SPS 360 (L) (MK2), SPS 370 (MK2), SPS 400 (MK2)
RAMS	RZ 1-755, RZ 1-800, RZ 1-850, RZ 1-955 L, RZ 1-465 LIGHT, RZ 1-580 LIGHT, RZ 1-1810 CROSSRAMMER, RZ 2-1290, RZ 2-1415 L, RZ 3-1640, RZD 2-1200, RZT 2-600, RZT 2-775, RZT 2-1170, RZT 2-1500, RZT 2-610 XL, RZT 2-1120 XL, RZT 2-1250 XL, RZT 2-1275 XL, RZT 2-1500 XL, RZT 3-1310 XL
SPECIAL TOOLS	BC 250, C 45-9, SPK 250, DO 120, SBH 15-255, MSE 15-255
POWER-UNITS	E/V 50..., E/V 70..., E/V 400 (S)..., V 400 ECO, B-COMPACT ECO, E-COMPACT, V 50 ECO, V-ECOCOMPACT, V-ECOSILENT, AKKUPAC ECO
HANDPUMPS/ACCESSORIES	DPH 0705..., DPH 3215..., DPH 4018..., DPF 4018 and accessories to all tools

meets the relevant basic safety and health requirements of the directive
EC-MACHINE DIRECTIVE 2006/42/EC

For the relevant implementation of the safety and health requirements mentioned in the Directive, the following standards and or technical specifications has been respected:

DIN EN 13204	DIN EN ISO 12100	DIN EN ISO 13857
NFPA 1936	NFS 61.571	

The tools are tested according to EN 13204 and NFPA 1936 trough TÜV-Süd.

Authorised person to compile the technical file(s):
Josef Eder - Head of Development

WEBER-HYDRAULIK GMBH
Industriegebiet 3+4
A-4460 Losenstein
Losenstein, 30.07.2019

i.V. Patrick Allinger
(Product Manager)

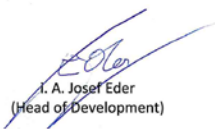
i. A. Josef Eder
(Head of Development)

WEBER-HYDRAULIK GmbH

Heilbronner Straße 30
74363 Güglingen / Germany
Telefon +49 (0) 7135/71-10270
Telefax +49 (0) 7135/71-10396
info@weber-rescue.com

Industriegebiet 3 + 4
4460 Losenstein / Austria
Telefon +43 (0) 7255/6237-120
Telefax +43 (0) 7255/6237-12461
info@weber-rescue.com

WEBERRESCUE
SYSTEMS

www.weber-rescue.com