









Cutter RSC 200 PLUS E-FORCE3

Part no.
1105491



E-FORCE3

-  SMOOTH CUT
-  FORGED
-  360° HANDLE
-  PLUS
-  CHARGE
-  X-CHANGE
-  LED LIGHTS
-  SPEED CONTROL

Technical data:

Opening width	202 mm
Weight (ready to use)	26.1 kg
Dimensions (LxWxH)	988 x 296 x 241 mm
Nominal pressure	700 bar
EN cutting class (EN 13204)	CC202K-26,1
EN cutting performance (EN 13204)	1K-2K-3K-4K-5K
NFPA cutting class (NFPA 1936)	A9-B9-C9-D9-E9-F5

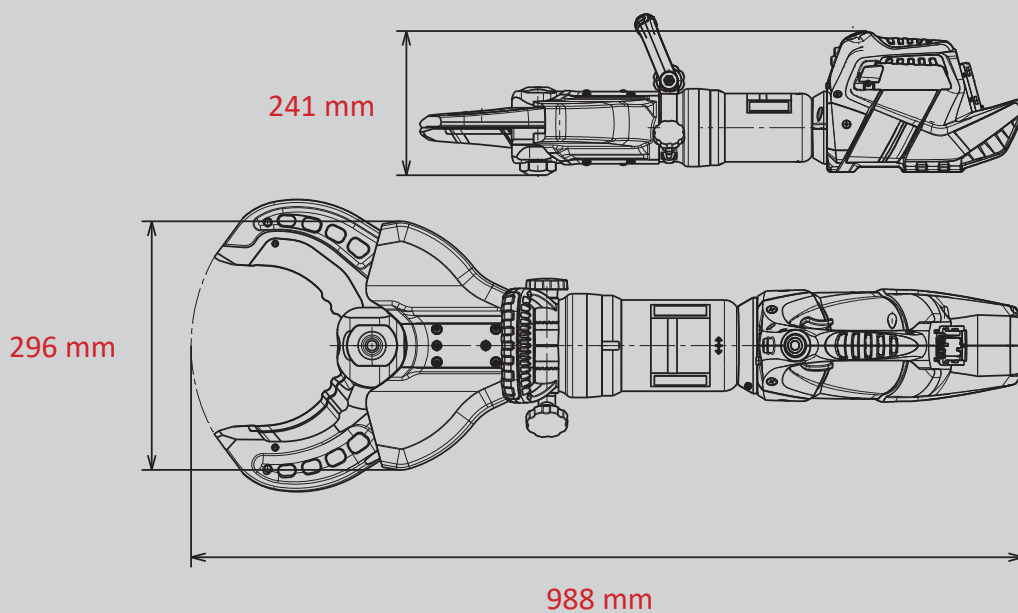

Images are non-binding. We reserve the right to technical modifications.
01/2025A